

## DATASHEET

# GZ115F / GZ215F SUPERCAPACITOR

Revision 4.6, Jan 2024

## Electrical Specifications

The GZ115F is a single cell supercapacitor. The GZ215F is a dual cell supercapacitor with two GZ115F cells in series, so GZ215F capacitance = Capacitance of GZ115F/2 and GZ215F ESR = 2 x GZ115F ESR.

**Table 1: Absolute Maximum Ratings**

Parameter	Name		Conditions	Min		Max	Units
Terminal Voltage	V <sub>peak</sub>	GZ115F		0		2.75	V
		GZ215F				5.5	
Temperature	T <sub>max</sub>			-40		+70	°C

**Table 2: Electrical Characteristics**

Parameter	Name		Conditions	Min	Typical	Max	Units
Terminal Voltage	V <sub>n</sub>	GZ115F		0		2.5	V
		GZ215F		0		5.0	
Capacitance	C	GZ115F	DC, 23°C	144	180	216	mF
		GZ215F		72	90	108	
ESR	ESR	GZ115F	DC, 23°C		55	66	mΩ
		GZ215F			110	132	
Leakage Current	I <sub>L</sub>		2.3V, 23°C 120hrs		1	2	μA
RMS Current	I <sub>RMS</sub>		23°C			4.5	A
Peak Current <sup>1</sup>	I <sub>P</sub>		23°C			30	A

<sup>1</sup>Non-repetitive current, single pulse to discharge fully charged supercapacitor.

**Table 3: Thickness**

<b>GZ115F</b>	<b>1.2mm</b>	No adhesive tape on underside of the supercapacitor	<b>GZ115G</b>	<b>1.3mm</b>	Adhesive tape on underside, release tape removed
<b>GZ215F</b>	<b>2.5mm</b>		<b>GZ215G</b>	<b>2.6mm</b>	

Note: The default version of this product has one heat-shrink tube over the positive terminal. The full part number is GZ115F-N, GZ215F-N, GZ115G-N or GZ215G-N.

### Definition of Terms

In its simplest form, the Equivalent Series Resistance (ESR) of a capacitor is the real part of the complex impedance. In the time domain, it can be found by applying a step discharge current to a charged cell as in Fig. 1. In this figure, the supercapacitor is pre-charged and then discharged with a current pulse,  $I = 1A$  for duration 0.01 sec.

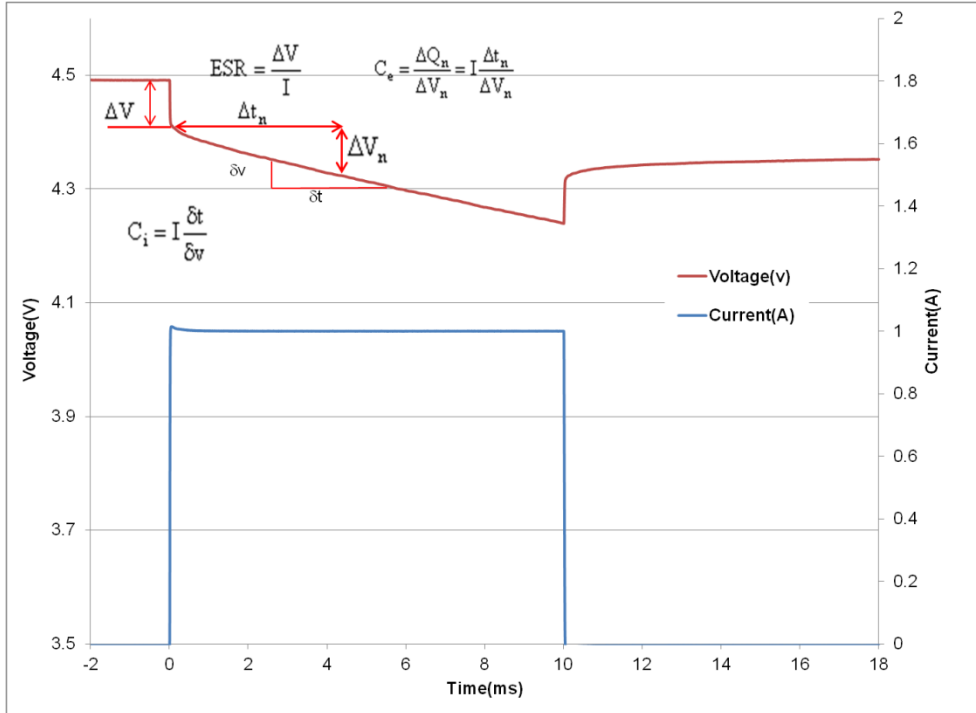

**Fig 1: Effective capacitance, instantaneous capacitance and ESR for a GZ215F**

The ESR is found by dividing the instantaneous voltage step ( $\Delta V$ ) by  $I$ . In this example  $= (4.49V - 4.42V)/1A = 30m\Omega$ .

The instantaneous capacitance ( $C_i$ ) can be found by taking the inverse of the derivative of the voltage, and multiplying it by  $I$ .

The effective capacitance for a pulse of duration  $\Delta t_n$ ,  $C_e(\Delta t_n)$  is found by dividing the total charge removed from the capacitor ( $\Delta Q_n$ ) by the voltage lost by the capacitor ( $\Delta V_n$ ). For constant current  $C_e(\Delta t_n) = I \times \Delta t_n / \Delta V_n$ .  $C_e$  increases as the pulse width increases and tends to the DC capacitance value as the pulse width becomes very long (~10 secs). After 2msecs, Fig 1 shows the voltage drop  $V_{2ms} = (4.42 V - 4.36V) = 60mV$ . Therefore  $C_e(2ms) = 1A \times 2ms / 60mV = 33.3mF$ . After 10ms, the voltage drop  $= 4.42 V - 4.24V = 180mV$ . Therefore  $C_e(10ms) = 1 A \times 10ms / 180mV = 55.6mF$ . The DC capacitance of a GZ215F = 90 mF. Note that  $\Delta V$ , or  $IR$  drop, is not included because very little charge is removed from the capacitor during this time.  $C_e$  shows the time response of the capacitor and it is useful for predicting circuit behaviour in pulsed applications.

### Measurement of DC Capacitance

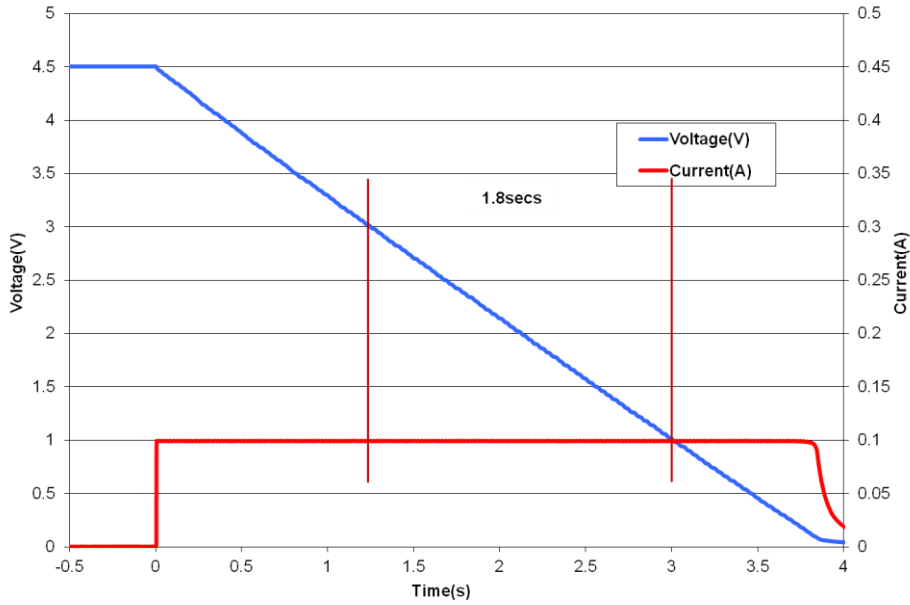

**Fig 2: Measurement of DC Capacitance for a GZ215F**

Fig 2 shows the measurement of DC capacitance by drawing a constant 100mA current from a fully charged supercapacitor and measuring the time taken to discharge from 1.5V to 0.5V for a single cell, or from 3V to 1V for a dual cell supercapacitor. In this case,  $C = 0.1A \times 1.8s / 2V = 90mF$ , which is well within the 90mF +/- 20% tolerance for a GZ215F cell.

### Measurement of ESR

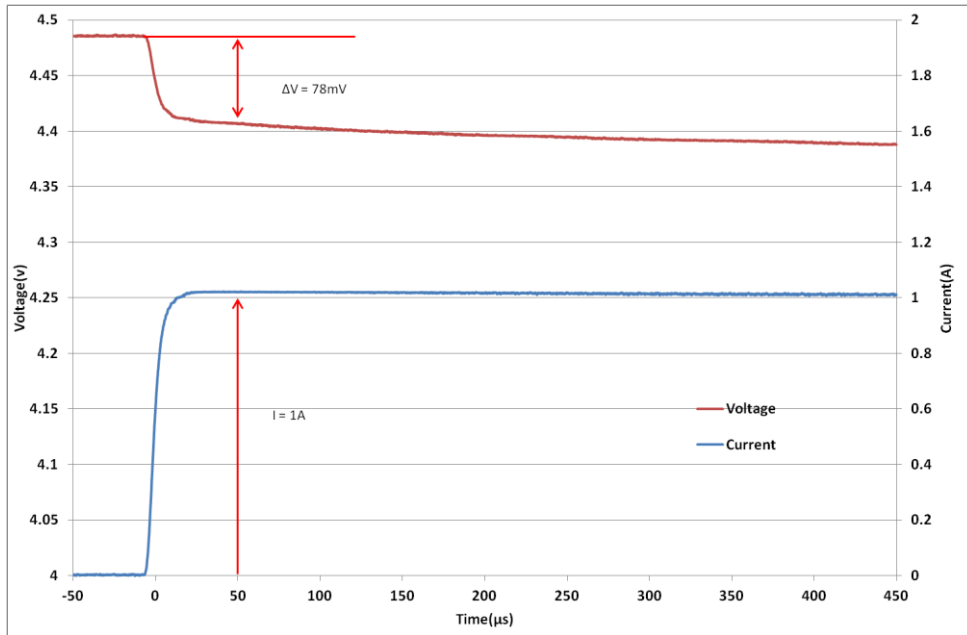

**Fig 3: Measurement of ESR for a GZ215F**

Fig 3 shows DC measurement of ESR by applying a step load current to the supercapacitor and measuring the resulting voltage drop. CAP-XX waits for a delay of 50μs after the step current is applied to ensure the voltage and current have settled. In this case the ESR is measured as  $78mV/1A = 78m\Omega$ .

## Effective Capacitance

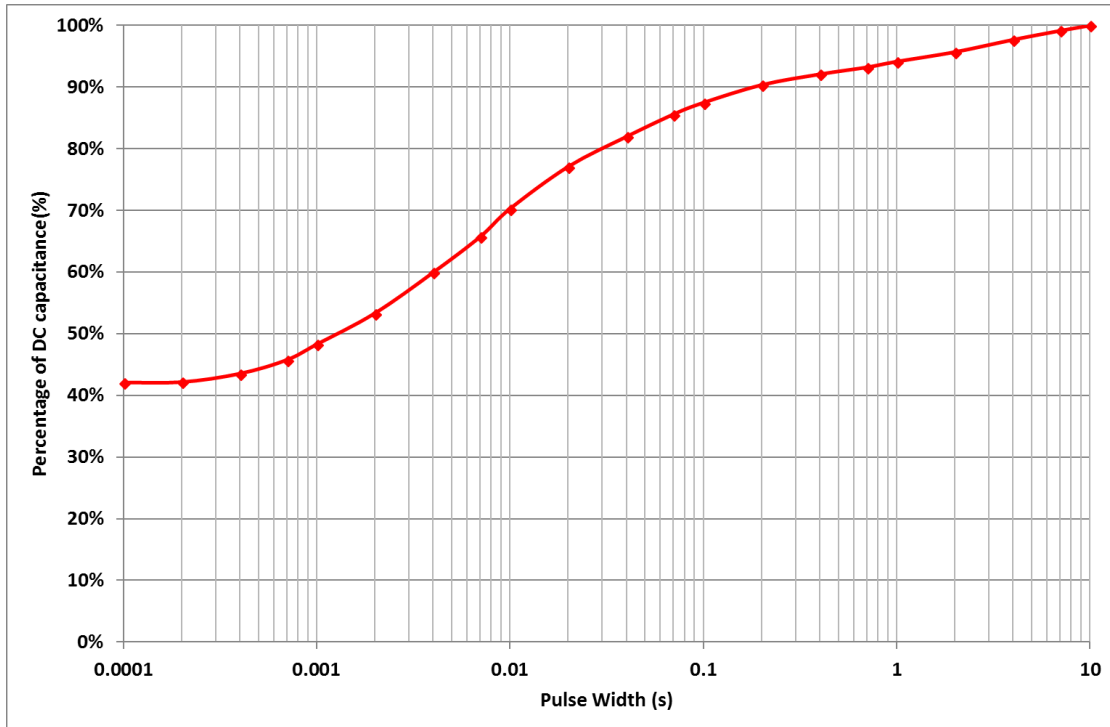

**Fig 4: Effective Capacitance**

Fig 4 shows the effective capacitance for the GZ115F, GZ215F @ 23°C. This shows that for a 1ms PW, you will measure 48% of DC capacitance or 86mF for a GZ115F or 43mF for a GZ215F. At 10ms you will measure 70% of the DC capacitance, and at 100ms you will measure 87% of DC capacitance. Effective is a time domain representation of the supercapacitor's frequency response. If, for example, you were calculating the voltage drop if the supercapacitor was supporting 1A for 10ms, then you would use the  $C_{eff}(10ms) = 70\%$  of DC capacitance = 63mF for a GZ215F, so  $V_{drop} = 1A \times ESR + 1A \times duration/C = 1A \times 110m\Omega + 1A \times 10ms / 63mF = 269mV$ . The next section on pulse response shows how the effective capacitance is sufficient for even short pulse widths.

## Pulse Response

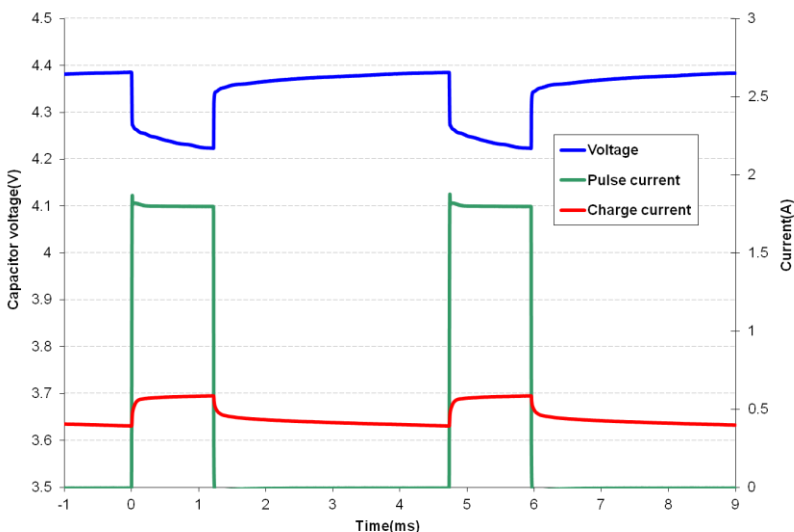
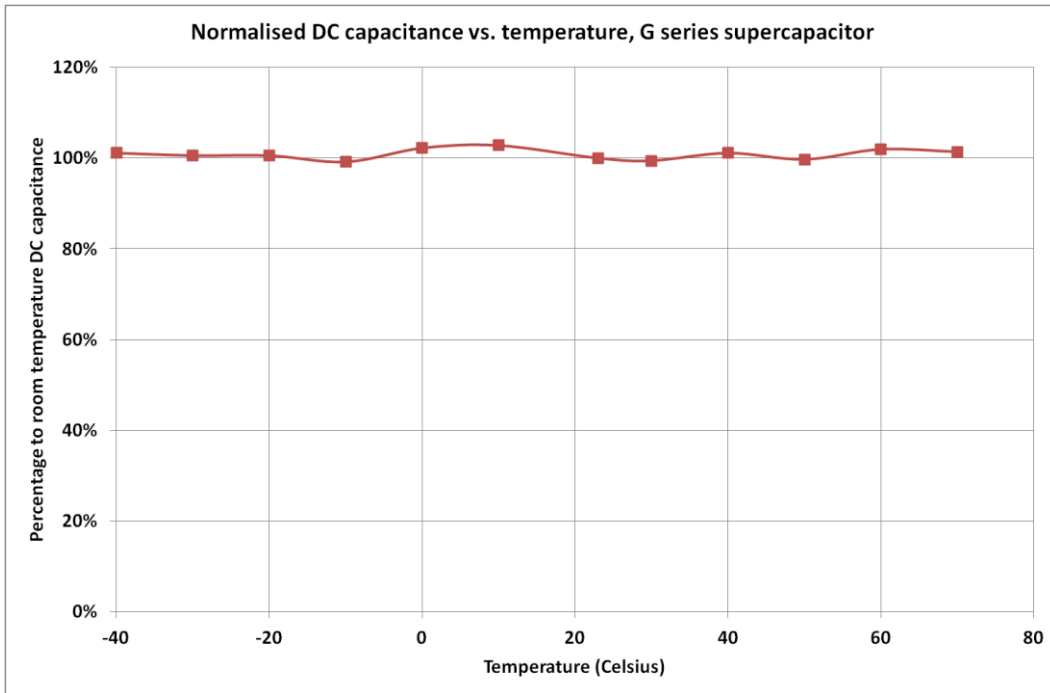

Fig 5 shows that the GZ215F supercapacitor does an excellent job supporting a GPRS class 10 pulse train, drawing 1.8A for 1.1ms at 25% duty cycle. The source is current limited to 0.6A and the supercapacitor provides the 1.2A difference to achieve the peak current. At first glance the freq response of Fig 8 indicates the supercapacitor would not support a 1ms pulse, but the  $C_{eff}$  of 43mF coupled with the low ESR supports this pulse train with only ~162mV drop in the supply rail.

**Fig 5: GZ215F Pulse Response with GPRS Class 10 Pulse Train**

## DC Capacitance variation with temperature



**Fig 6: Capacitance change with temperature**

Fig 6 shows that DC capacitance is approximately constant with temperature.

## ESR variation with temperature

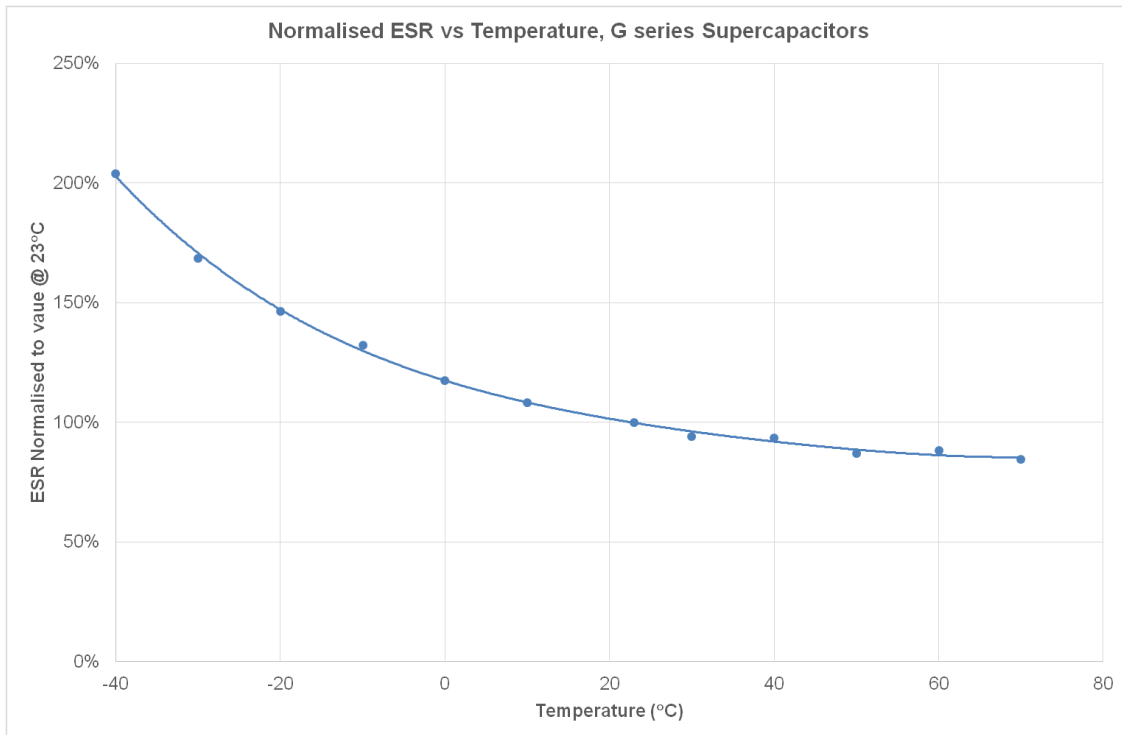

**Fig 7: ESR change with temperature**

Fig 7 shows that ESR at -40°C is ~2 x ESR at room temp, and that ESR at 70°C is ~0.85 x ESR at room temperature.

### Frequency Response

GZ215 Magnitude and Phase vs. Frequency

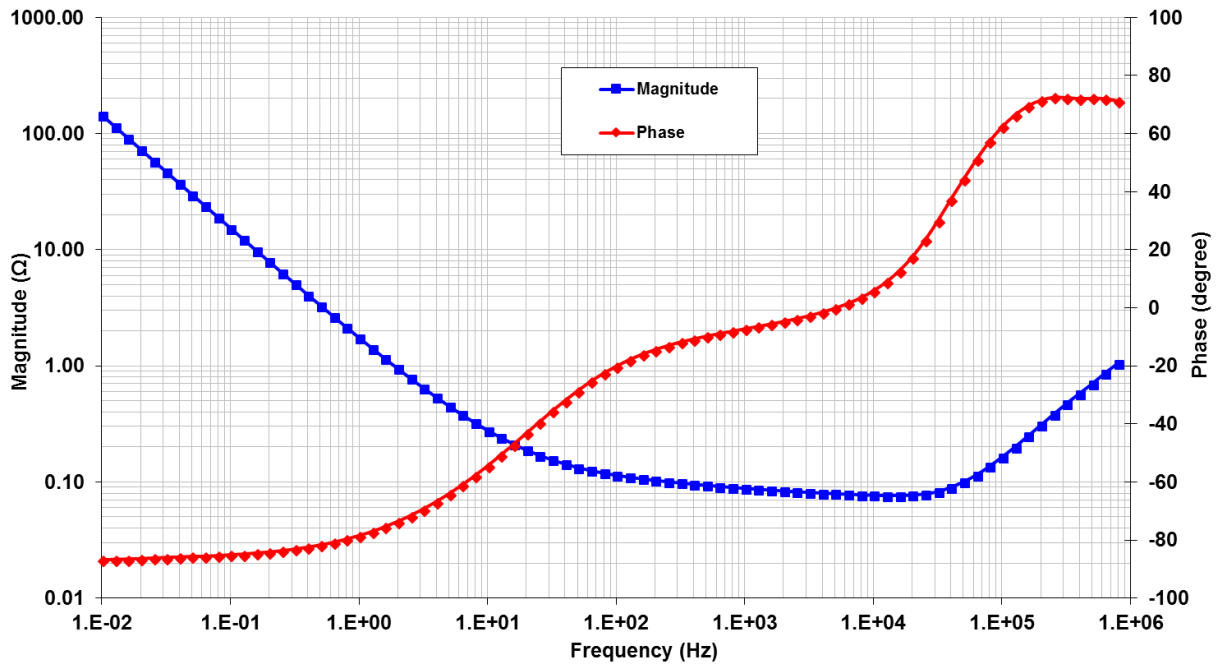

Fig 8: Frequency Response of Impedance (biased at 5V with a 50mV test signal)

GZ215 ESR, Capacitance and Inductance vs. Frequency

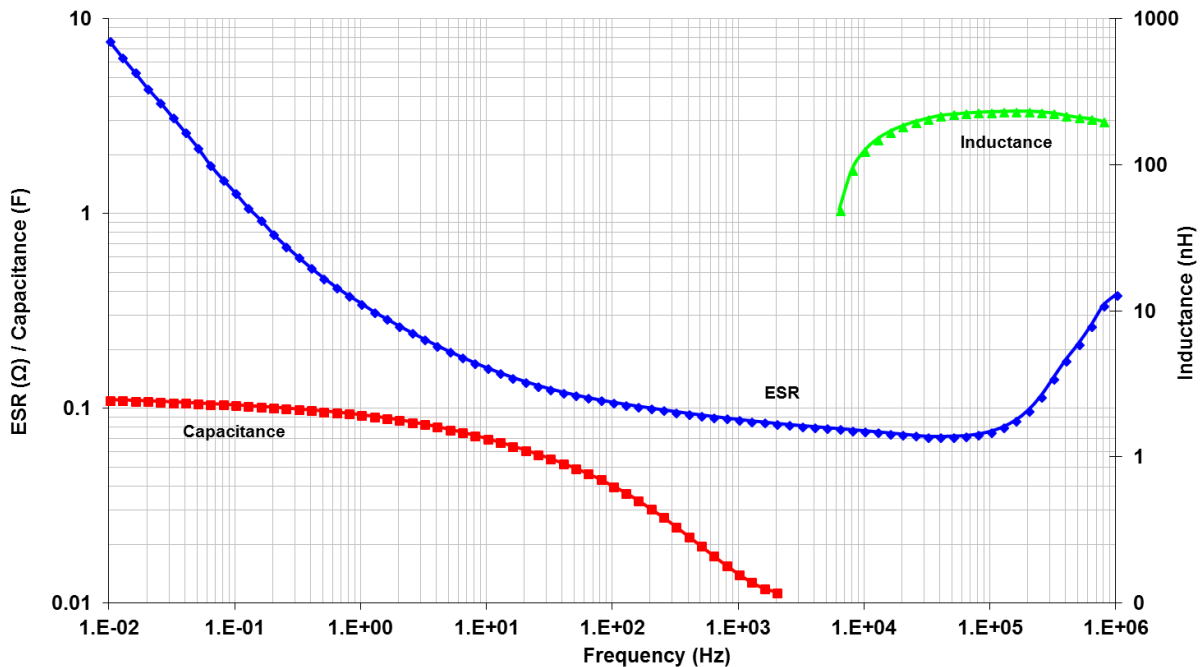
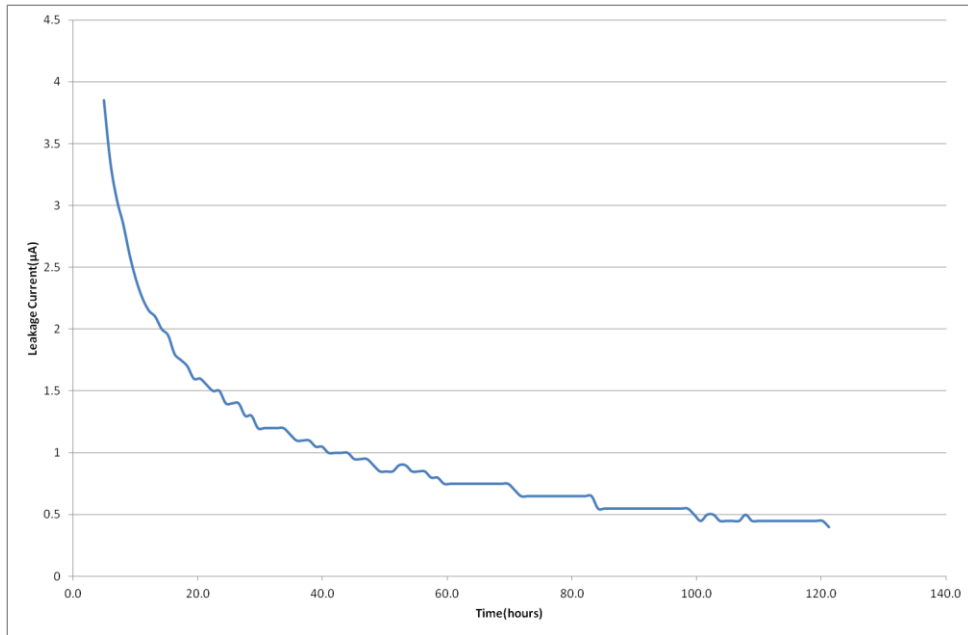

Fig 9: Frequency Response of ESR, Capacitance & Inductance

Fig 8 shows the supercapacitor behaves as an ideal capacitor until approx 20 Hz when the magnitude no longer rolls off proportionally to 1/freq and the phase crosses -45°. Performance of supercapacitors with frequency is complex and the best predictor of performance is Fig 4 showing effective capacitance as a function of pulsewidth.

## Leakage Current



**Fig 10: Leakage Current**

Fig 10 shows the leakage current for GZ115F at room temperature. The leakage current decays over time, and the equilibrium value leakage current will be reached after ~120hrs at room temperature. The typical equilibrium leakage current is 0.5µA at room temperature. At 70°C leakage current will be ~5µA.

## Charge Current

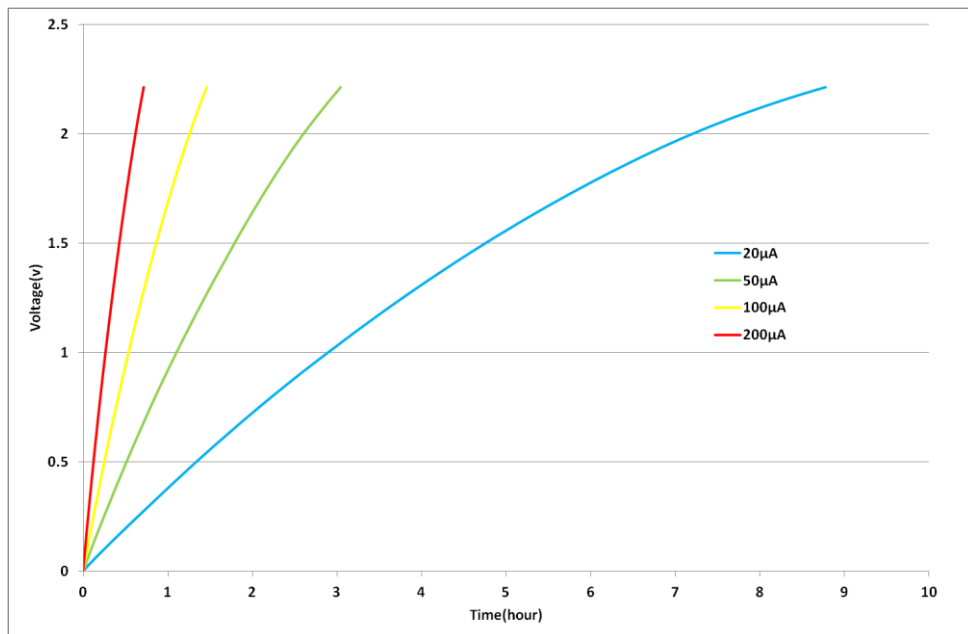

**Fig 11: Charging a GZ115F with low current**

The corollary to the slow decay in leakage currents shown in Fig 10 is that charging a supercapacitor at very low currents takes longer than theory predicts. At higher charge currents, the charge rate is as theory predicts. For example, it should take  $0.18F \times 2.2V / 0.00002A = 5.5hrs$  to charge a 0.18 F supercapacitor to 2.2V at 20µA, but Fig 11 shows it took 9hrs. At 100µA charging occurs at a rate close to the theoretical rate.

## RMS Current

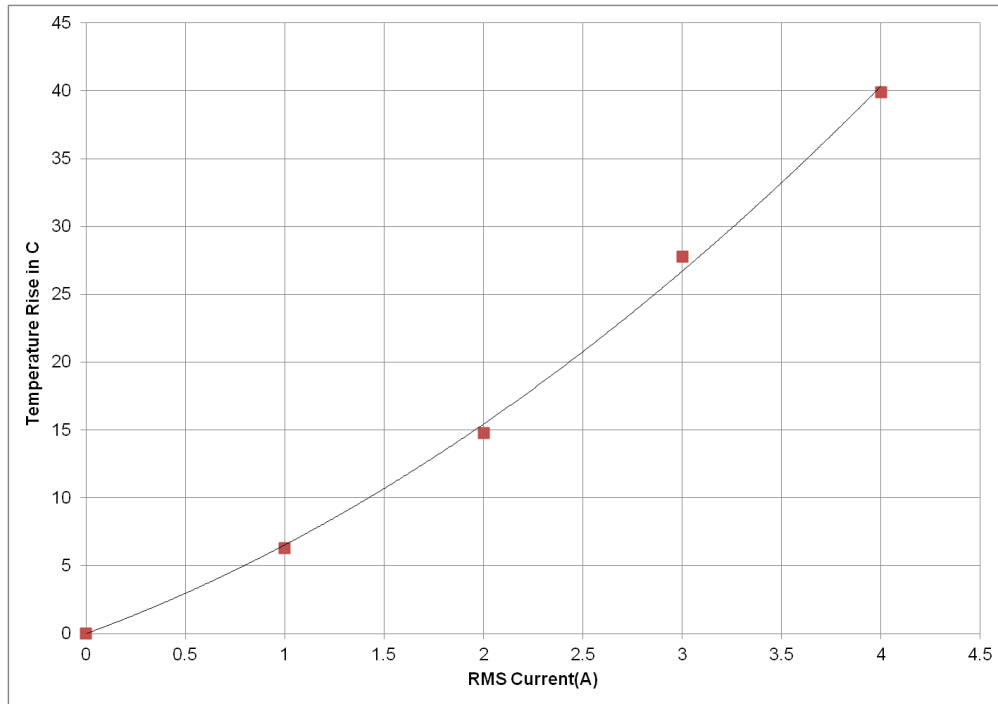

**Fig 12: Temperature rise in GZ215F with RMS current**

Continuous current flow into/out of the supercap will cause self heating, which limits the maximum continuous current the supercapacitor can handle. This is measured by a current square wave with 50% duty cycle, charging the supercapacitor to rated voltage at a constant current, then discharging the supercapacitor to half rated voltage at the same constant current value. For a square wave with 50% duty cycle, the RMS current is the same as the current amplitude. Fig 12 shows the increase in temperature as a function of RMS current. From this, the maximum RMS current in an application can be calculated, for example, if the ambient temperature is 40°C, and the maximum desired temperature for the supercapacitor is 70°C, then the maximum RMS current should be limited to 3.2A, which causes a 30°C temperature increase.

## CAP-XX Supercapacitors Product Guide

Refer to the package drawings in the [CAP-XX Supercapacitors Product Guide](#) for detailed information of the product's dimensions, PCB landing placements, active areas and electrical connections, as well for information on endurance and shelf life, transportation and storage, assembly and soldering, safety and RoHS/REACH certification.



**GZ115F / GZ215F DATASHEET**

**Package Drawings**

**Single cell**

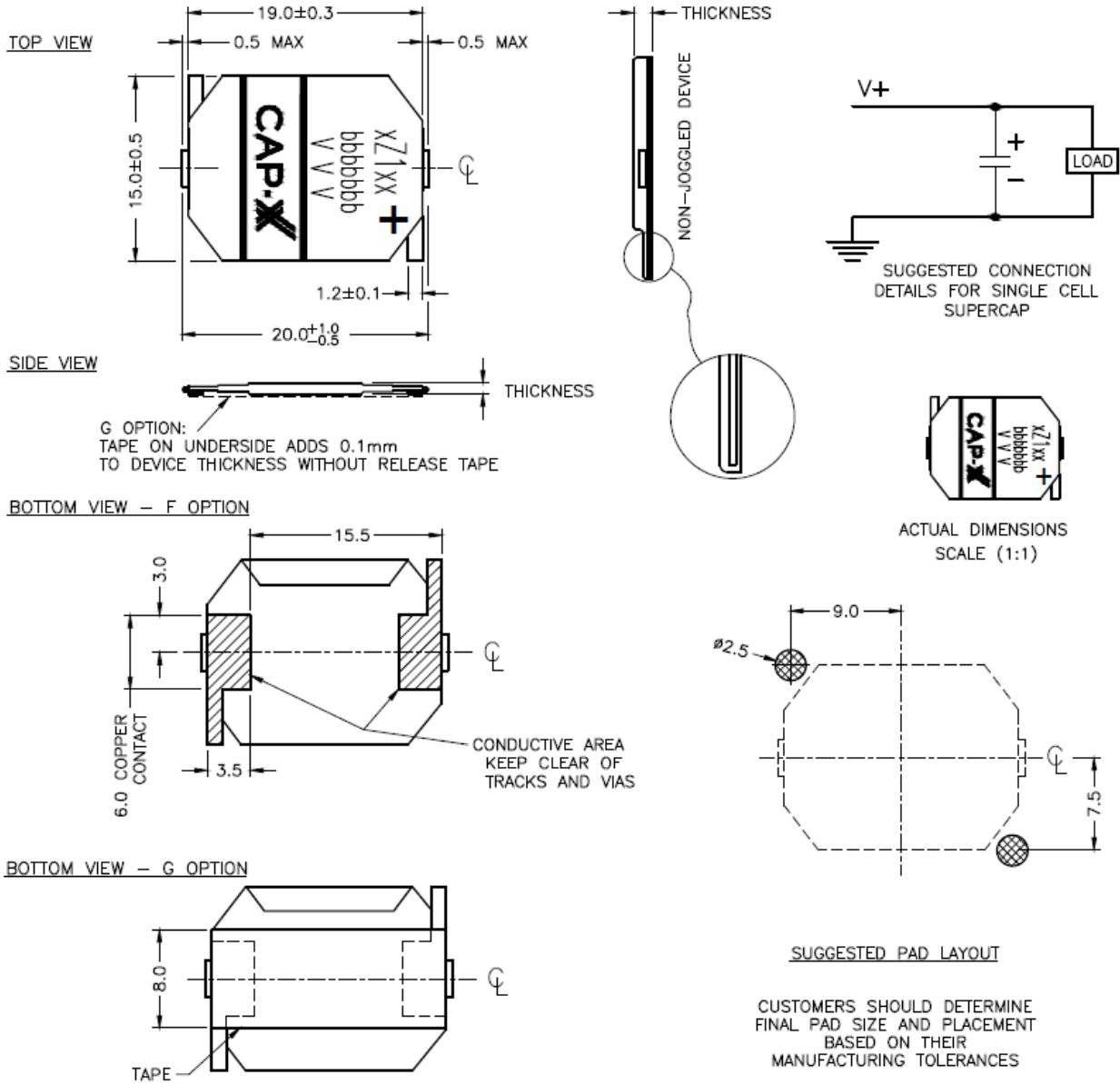

**GZ115F / GZ215F DATASHEET**

**Dual cell**

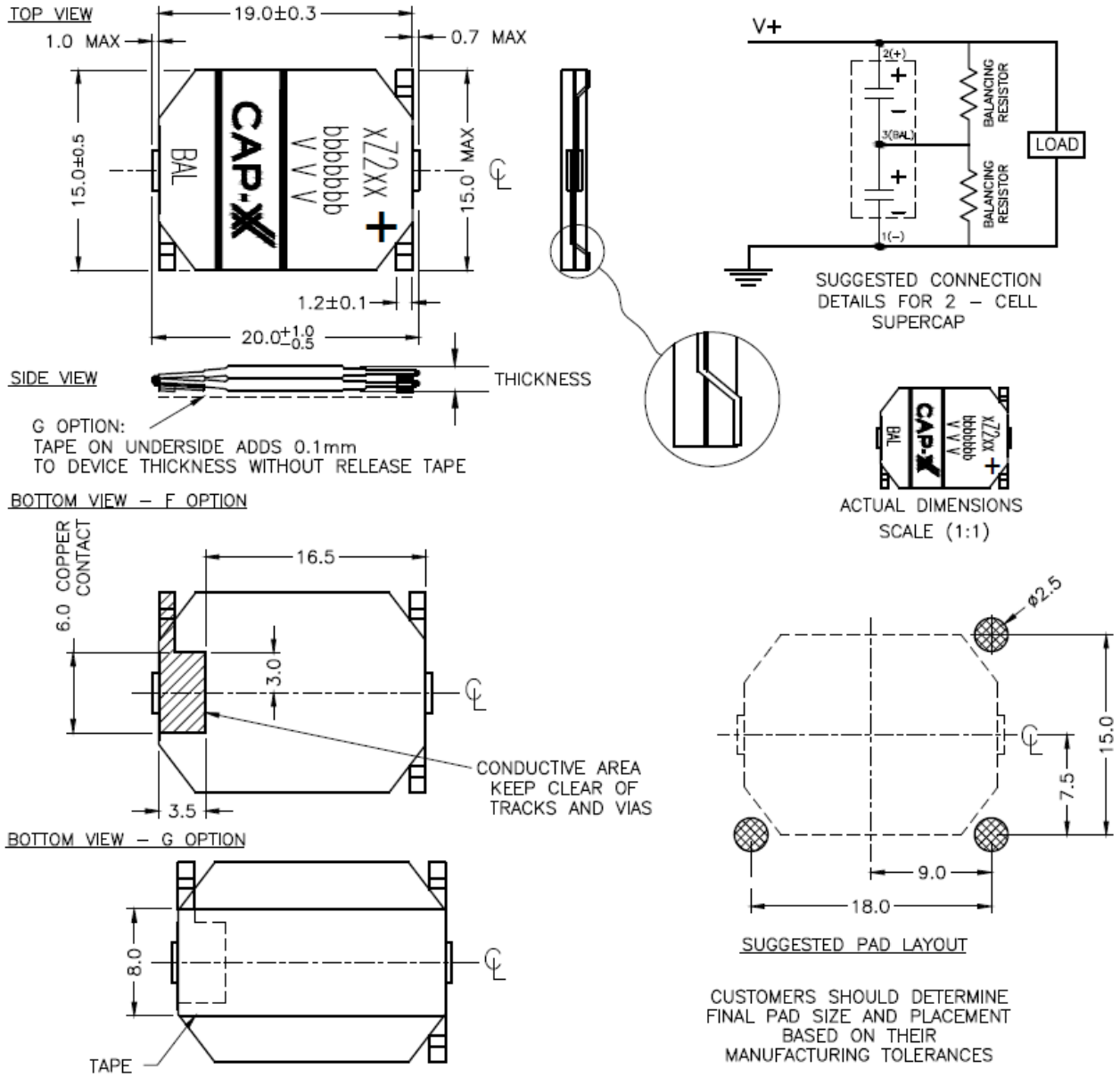

This datasheet should be read in conjunction with the [CAP-XX Supercapacitor Product Guide](#) which contains information common to our product lines.